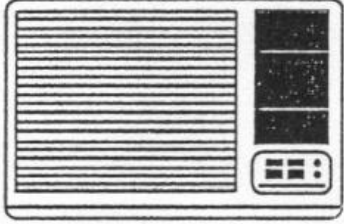




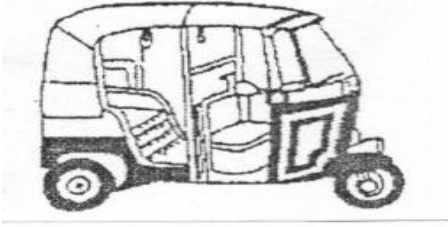


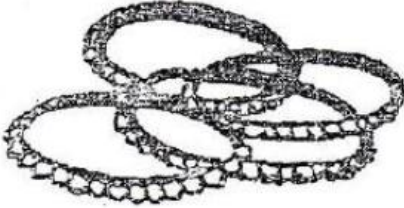

सारणी - IV



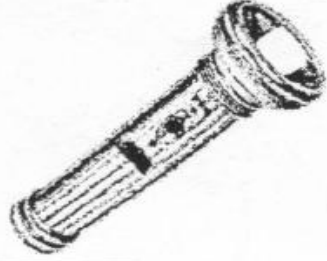

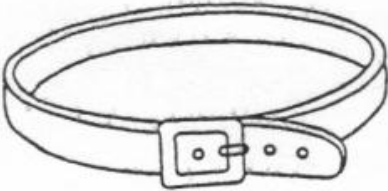
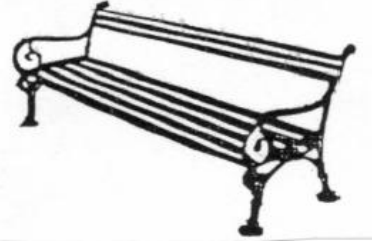
मुक्त प्रतीकों की सूची

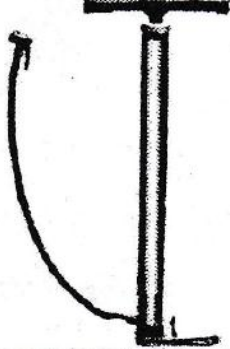


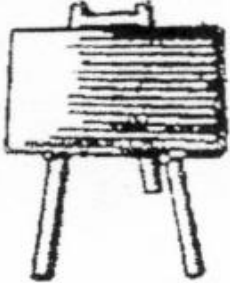

TABLE-IV

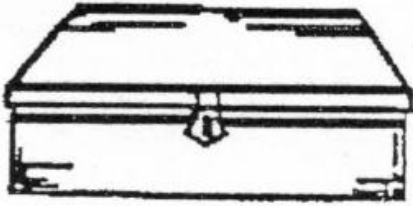


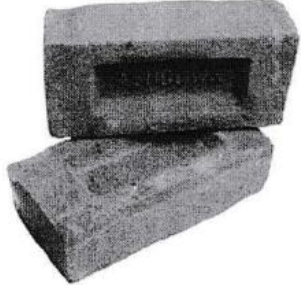
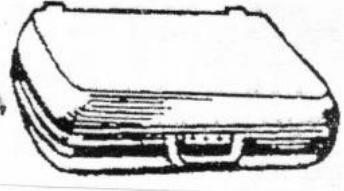

(LIST OF FREE SYMBOLS)


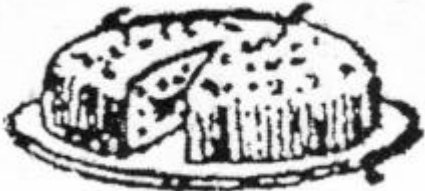
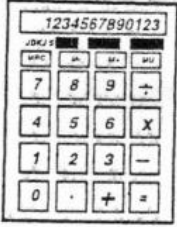
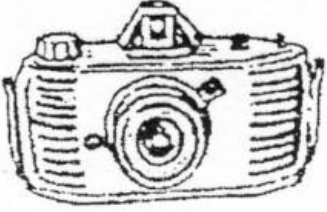


S.No	Symbol	Image	प्रतीक
1.	Air Conditioner		एअरकंडीस्नर
2.	Almirah		अलमारी
3.	Apple (In all States and Union Territories except in the States of Arunachal Pradesh, Assam, Manipur, Meghalaya, Mizoram, Nagaland, Sikkim, Tripura, Puducherry, Tamil Nadu, Kerala & Karnataka)		सेब (अरुणाचल प्रदेश, असम, मणिपुर, मेघालय, मिजोरम, नागालैंड, सिक्किम, त्रिपुरा, पुडुचेरी, तमिलनाडू, केरल एवं कर्नाटक राज्यों को छोड़कर सभी)

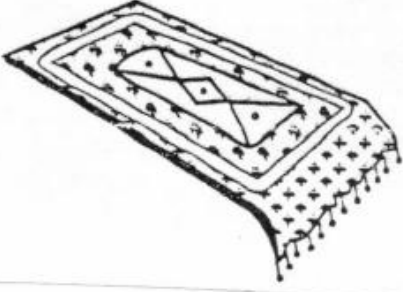
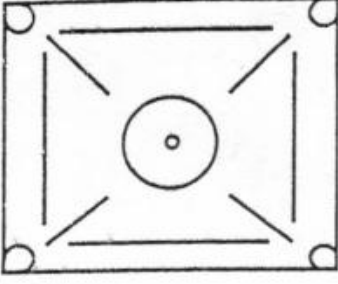
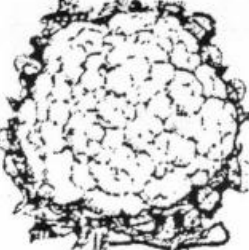

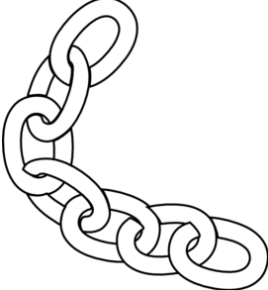
			राज्यों और संघ राज्य क्षेत्रों में)
4.	Auto- Rickshaw (In all States and Union Territories except in the States of Andhra Pradesh and Telangana)		ऑटो-रिक्शा (आंध्र प्रदेश एवं तेलंगाना राज्यों को छोड़कर सभी राज्यों और संघ राज्य क्षेत्रों में)
5.	Baby Walker		बेबी वॉकर
6.	Balloon		गुब्बारा
7.	Bangles		चूड़ियाँ
8.	Basket containing Fruits (In all States and Union Territories except in the State of Tamil Nadu)		फलों से युक्त टोकरी (तमिल नाडू राज्य को छोड़कर सभी राज्यों और संघ राज्य क्षेत्रों में)

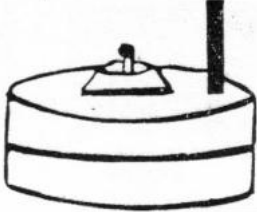


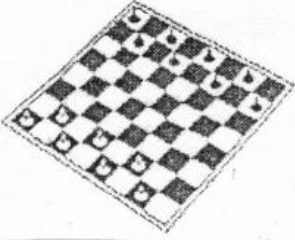


9.	Bat		बल्ला
10.	Batsman		बल्लेबाज
11.	Battery Torch		बैटरी टार्च
12.	Bead Necklace		मोतियों का हार
13.	Belt		बेल्ट
14.	Bench		बेन्च


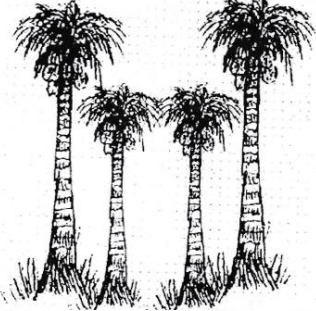
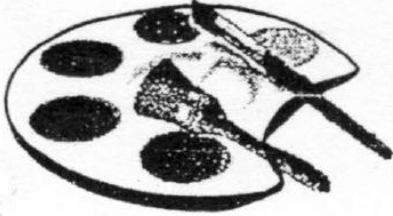
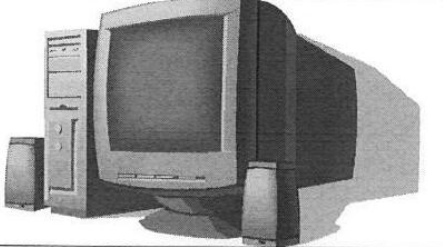

15.	Bicycle Pump		साइकिल पम्प
16.	Binoculars		दूरबीन
17.	Biscuit		बिस्कुट
18.	Black Board		ब्लैक बोर्ड
19.	Boat with Man and Sail		आदमी व पाल युक्त नौका

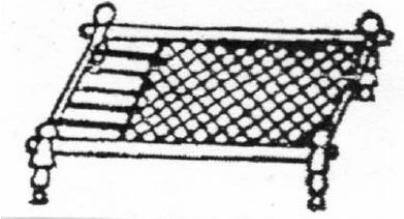
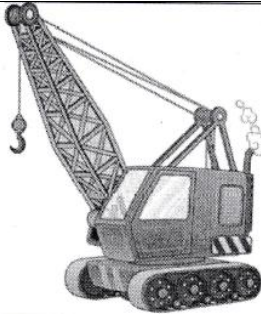
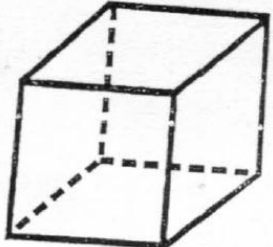

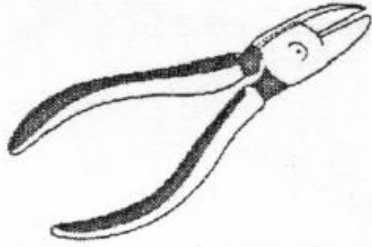
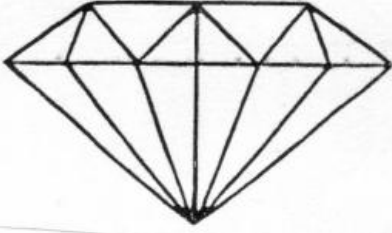
20.	Box		बक्सा
21.	Bread		डबल रोटी
22.	Bread Toaster		ब्रेड टोस्टर
23.	Bricks		ईंटें
24.	Brief Case		ब्रीफकेस
25.	Brush		ब्रुश

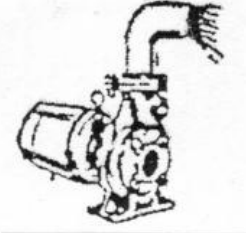

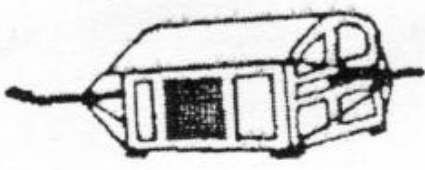


26.	Bucket		बाल्टी
27.	Cake		केक
28.	Calculator		कैलकुलेटर
29.	Camera		कैमरा
30.	Can		कैन
31.	Capsicum		शिमला मिर्च

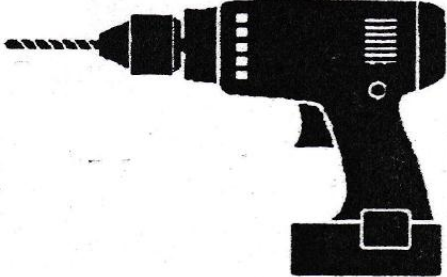
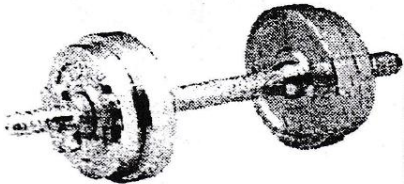

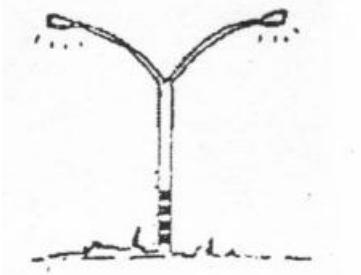
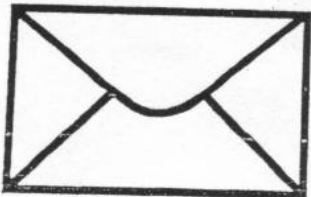
32.	Carpet		कार्पेट
33.	Carron Board		कैरम बोर्ड
34.	Cauliflower		फूलगोभी
35.	CCTV Camera		सीसीटीवी कैमरा
36.	Chain		जंजीर

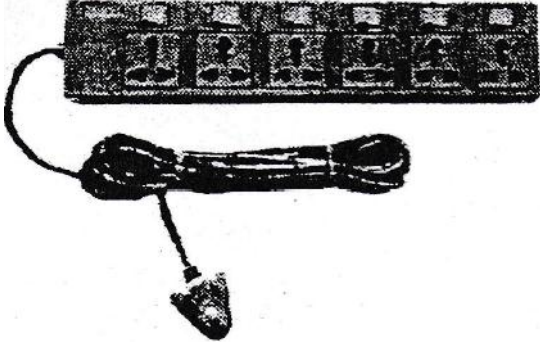
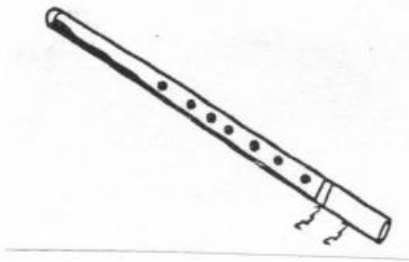


37.	Chakki		चक्की
38.	Chapati Roller		चपाती रोलर
39.	Chappals		चप्पलें
40.	Chess Board		शतरंज बोर्ड
41.	Chimney		चिमनी
42.	Clip		चिमटी






43.	Coat		कोट
44.	Coconut Farm		नारियल फार्म
45.	Colour Tray & Brush		कलर ट्रे और ब्रुश
46.	Computer		कम्प्यूटर
47.	Computer Mouse		कम्प्यूटर माउस


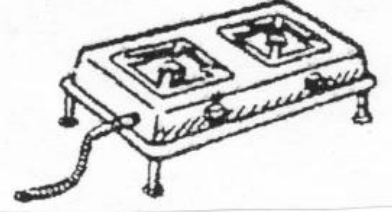




48.	Cot (In all States and Union Territories except in the State of Kerala)		चारपाई (केरल राज्य को छोड़कर सभी राज्यों और संघ राज्य क्षेत्रों में)
49.	Crane		क्रेन
50.	Cube		घन
51.	Cup & Saucer		कप और प्लेट
52.	Cutting Pliers		कटिंग प्लायर
53.	Diamond		हीरा



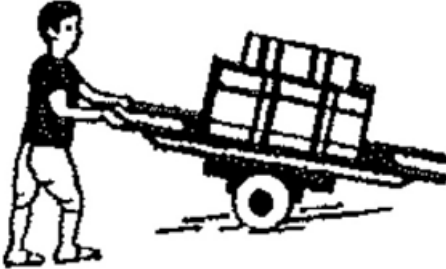
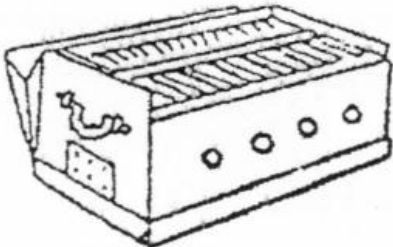

54.	Diesel Pump		डीजल पम्प
55.	Dish Antenna		डिश एंटीना
56.	Dolli		डोली
57.	Door Bell		द्वार घंटी
58.	Door Handle <i>(In all States and Union Territories except in the States of Uttar Pradesh and Uttarakhand)</i>		दरवाजे का हैंडल (उत्तर प्रदेश एवं उत्तराखण्ड राज्य को छोड़कर सभी राज्यों और संघ राज्य क्षेत्रों में)




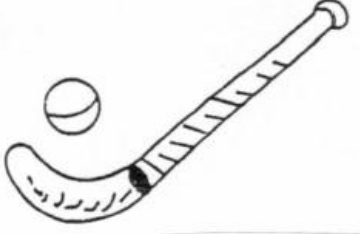

59.	Drill Machine		ड्रिल मशीन
60.	Dumbbells		डम्बल्स
61.	<p>Ear Rings <i>(In all States and Union Territories except in the States of Tamil Nadu, Puducherry, Kerala and Karnataka)</i></p>		<p>कान का बालियाँ (तमिलनाडू, पुडुचेरी, केरल एवं कर्नाटक राज्य को छोड़कर सभी राज्यों और संघ राज्य क्षेत्रों में)</p>
62.	Electric Pole		बिजली का खंभा
63.	Envelope		लिफाफा


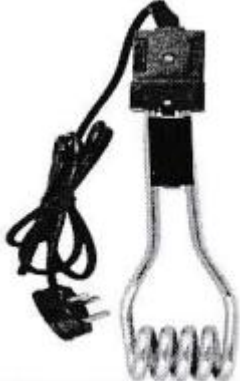
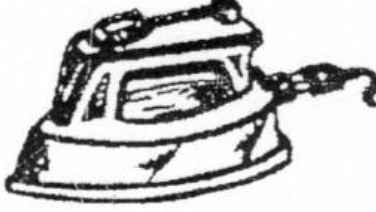

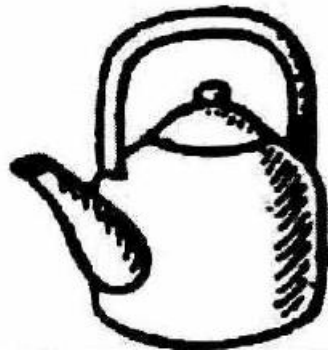
64.	Extension Board		एक्सटेंशन बोर्ड
65.	Flute		बाँसुरी
66.	<p>Football (In all States and Union Territories except in the States of Arunachal Pradesh, Assam, Manipur, Meghalaya, Mizoram, Nagaland, Sikkim and Tripura)</p>		<p>फुटबॉल (अरुणाचल प्रदेश, असम, मणिपुर, मेघालय, मिजोरम, नागालैंड, सिक्किम, एवं त्रिपुरा राज्यों को छोड़कर सभी राज्यों और संघ राज्य क्षेत्रों में)</p>
67.	Football Player		फुटबॉल खिलाड़ी

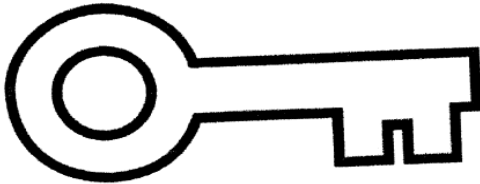


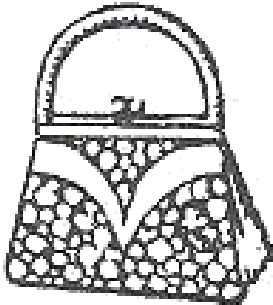
68.	Fountain		फव्वारा
69.	Frock		फ्राक
70.	Frying Pan		फ्राइंग पैन
71.	Funnel		कीप
72.	Ganna Kisan		गन्ना किसान


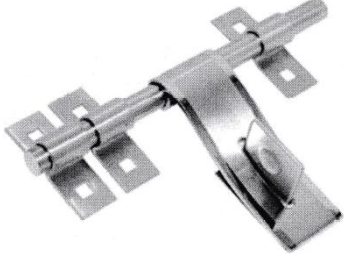

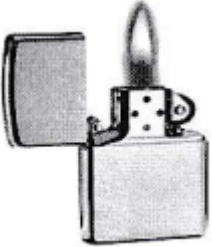
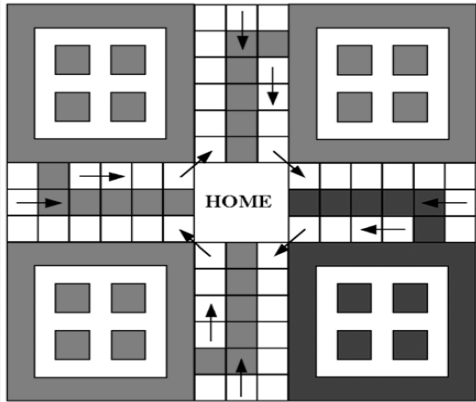
73.	Gas Cylinder		गैस सिलेण्डर
74.	Gas Stove		गैस का चूहा
75.	Gift Pack		उपहार
76.	Ginger		अदरक
77.	Glass Tumbler		काँच का गिलास
78.	Gramophone		ग्रामोफोन

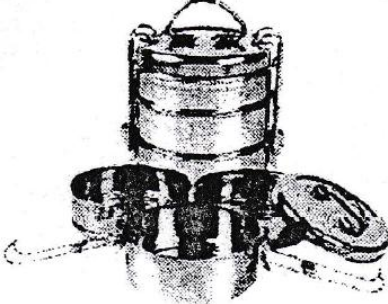
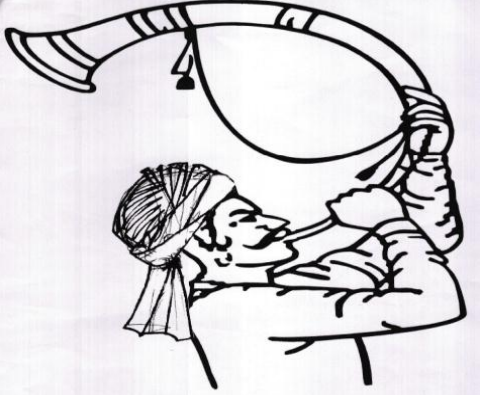


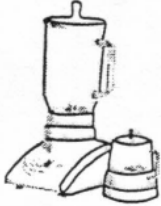
79.	Grapes		अंगूर
80.	Green Chilli		हरी मिर्च
81.	Hand Cart		हाथ गाड़ी
82.	Harmonium		हारमोनियम
83.	<p>Hat (In all States and Union Territories except in the States of Andhra Pradesh and Telangana)</p>		<p>टोप (आंध्र प्रदेश एवं तेलंगाणा राज्य को छोड़कर सभी राज्यों और संघ राज्य क्षेत्रों में)</p>

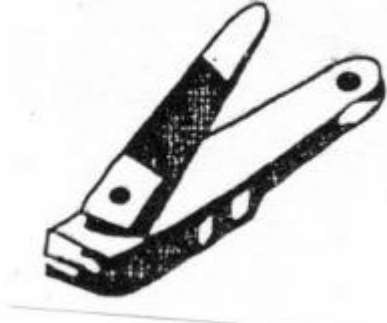

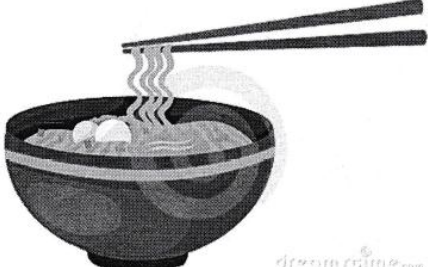


84.	Head Phone		हेडफोन
85.	Helicopter		हैलीकॉप्टर
86.	Helmet		हेलमेट
87.	Hockey and Ball		हाकी और बाल
88.	Hour Glass		रेत घड़ी

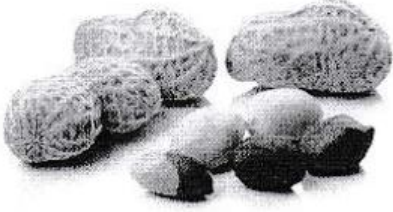
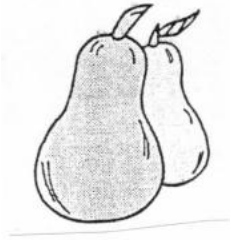
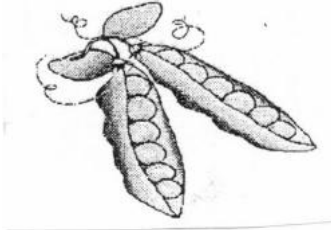

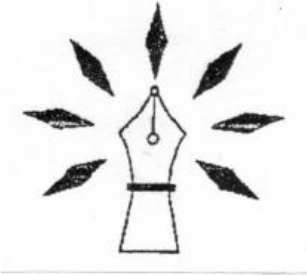
89.	Ice Cream <i>(In all States and Union Territories except in the State of Tamil Nadu)</i>		आइस क्रीम <i>(तमिल नाडू राज्य को छोड़कर सभी राज्यों और संघ राज्य क्षेत्रों में)</i>
90.	Immersion Rod		पानी गरम करने की रॉड
91.	Iron		प्रेस
92.	Jackfruit		कटहल
93.	Kettle <i>(In all States and Union Territories except in the States of Arunachal Pradesh, Assam, Manipur, Meghalaya, Mizoram, Nagaland, Sikkim,</i>		केतली <i>(अरुणाचल प्रदेश, असम, मणिपुर, मेघालय, मिजोरम, नागालैंड, सिक्किम, त्रिपुरा</i>

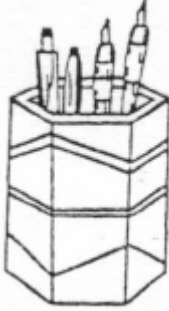
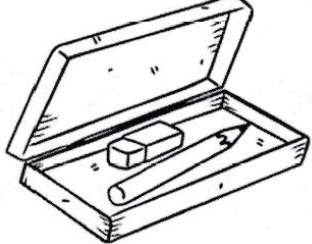
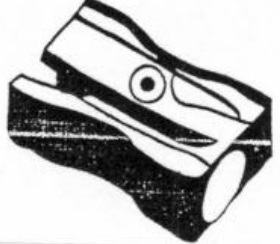
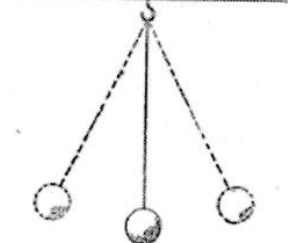

	<i>Tripura and West Bengal)</i>		एवं पश्चिम बंगाल राज्यों को छोड़कर सभी राज्यों और संघ राज्य क्षेत्रों में)
94.	Key		चाबी
95.	Kitchen Sink		किचन सिंक
96.	Lady Finger		भिंडी
97.	Lady Purse <i>(In all States and Union Territories except in the States of Arunachal Pradesh, Assam, Manipur, Meghalaya, Mizoram, Nagaland, Sikkim, Tripura and West Bengal)</i>		लेडी पर्स <i>(अरुणाचल प्रदेश, असम, मणिपुर, मेघालय, मिजोरम, नागालैंड, सिक्किम, त्रिपुरा एवं पश्चिम बंगाल राज्यों को छोड़कर सभी</i>



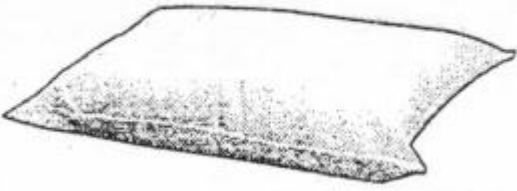


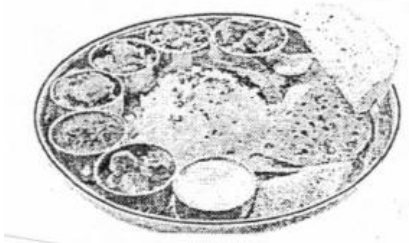
			राज्यों और संघ राज्य क्षेत्रों में)
98.	Laptop		लैपटॉप
99.	Latch		कुन्डी
100	Letter Box		लैटर बाक्स
101	Lighter		लाइटर
102	Ludo		लूडो

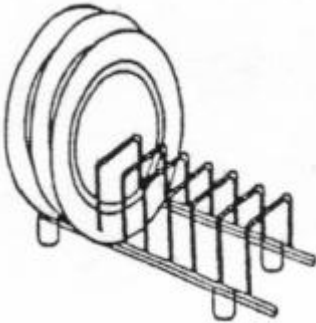

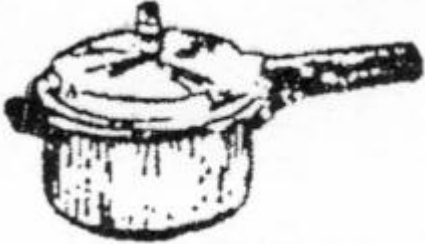

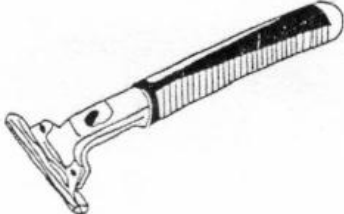
103	Lunch Box		लन्च बॉक्स
104	Man Blowing Turha		तुरहा बजाता आदमी
105	Matchbox		माचिस की डिब्बी
106	Mike		माईक
107	Mixee		मिक्सी



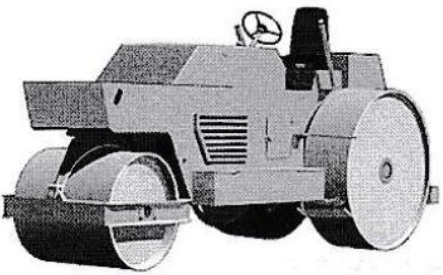


108	Nail Cutter		नेल कटर
109	Neck Tie		गले की टाई
110	Noodles Bowl		नूडल्स कटोरा
111	Pan		कड़ाही
112	Pants		पैंट

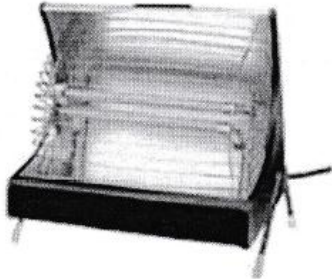
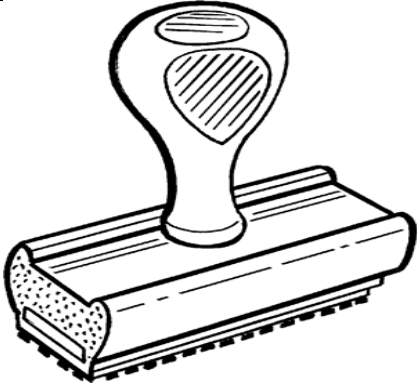

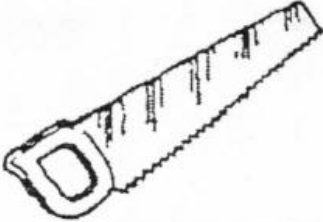

113	Peanuts		मूँगफली
114	Pears (Except in Tamil Nadu and Pudducherry)		नाशपाती (तमिल नाडू एवं पुडुचेरी राज्य को छोड़कर सभी राज्यों और संघ राज्य क्षेत्रों में)
115	Peas		मटर
116	Pen Drive		पेन ड्राइव
117	Pen Nib with Seven Rays		कलम की निब सात किरणों के साथ

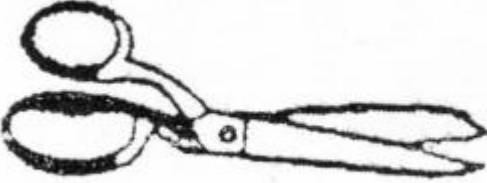
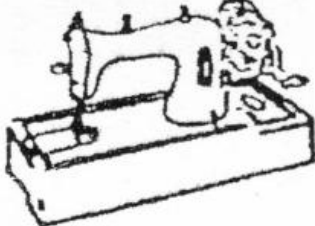

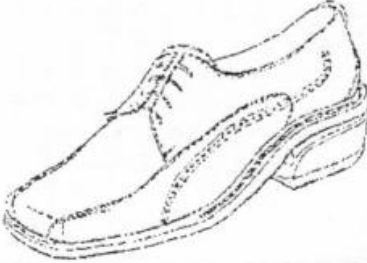
118	Pen Stand		पैन-स्टैण्ड
119	Pencil Box		पेन्सिल डिब्बा
120	Pencil Sharpener		पेन्सिल शार्पनर
121	Pendulum		पेन्डुलम
122	Pestle and Mortar		मूसल और खरल



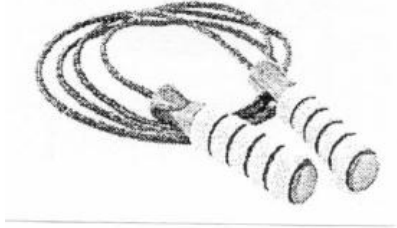
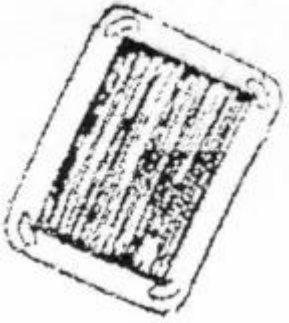
123	Petrol Pump		पेट्रोल पम्प
124	Phone Charger		फोन चार्जर
125	Pillow		तकिया
126	Pineapple		अनानास
127	Plastering Trowel		करनी
128	Plate Containing Food		खाने से भरी थाली






129	Plate Stand		प्लेट स्टैण्ड
130	Pot		हान्डी
131	Pressure Cooker		प्रेशर कुकर
132	Punching Machine		पंचिंग मशीन
133	Razor		रेजर




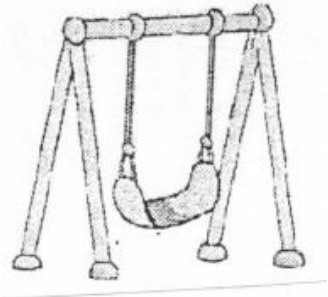
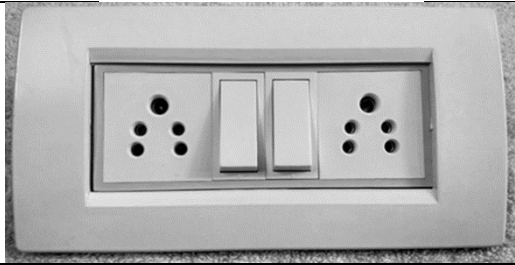
134	Refrigerator		रेफ्रिजरेटर
135	Ring		अंगुठी
136	Road Roller		रोड रोलर
137	Robot		रोबोट
138	Room Cooler		रूम कूलर



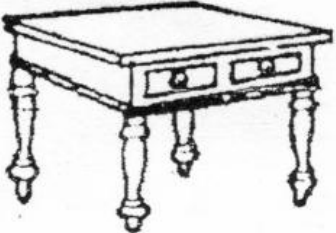
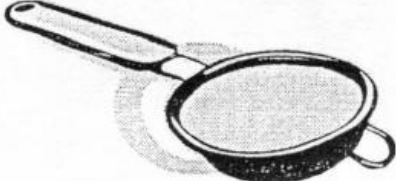

139	Room Heater		रूम हीटर
140	Rubber Stamp		रबर की मुहर
141	Safety Pin		सेफ्टी पिन
142	<p>Saw (In all States and Union Territories except in the State of Kerala)</p>		<p>आरी (केरल राज्य को छोड़कर सभी राज्यों और संघ राज्य क्षेत्रों में)</p>
143	School Bag		स्कूल का बस्ता

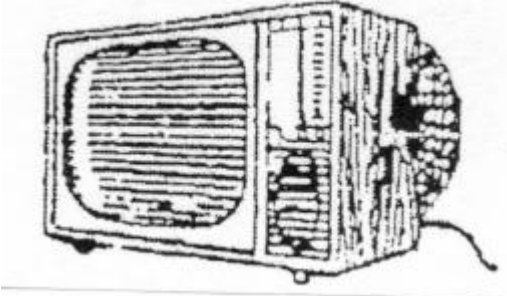
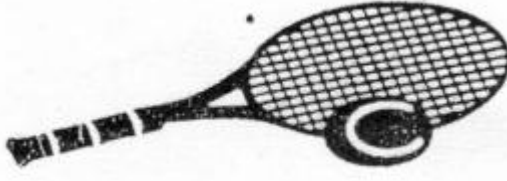
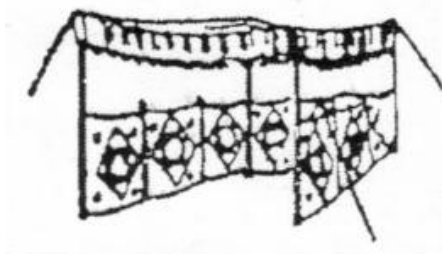

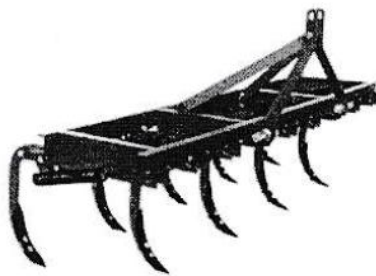
144	Scissors		कैंची
145	Sewing Machine		सिलाई की मशीन
146	Ship		पानी का जहाज
147	Shoe		जूता

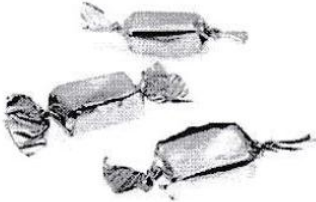
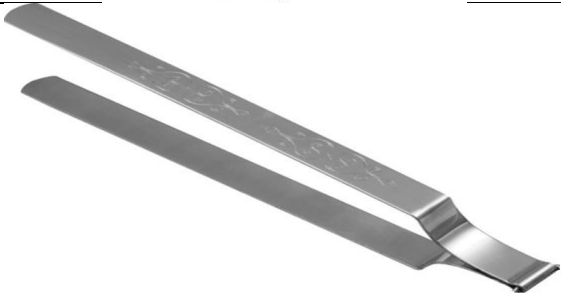
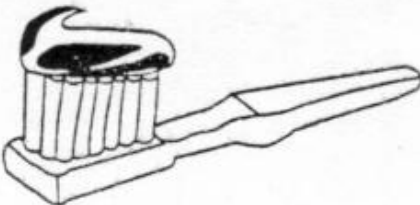
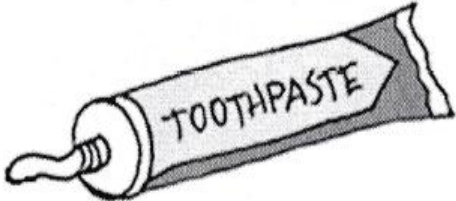

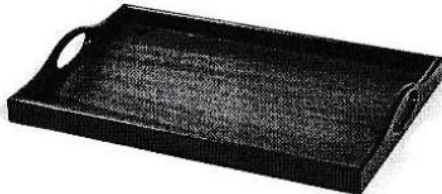
148	Shutter		शटर
149	Sitar		सितार
150	Skipping Rope		कूदने की रस्सी
151	Slate		स्लेट

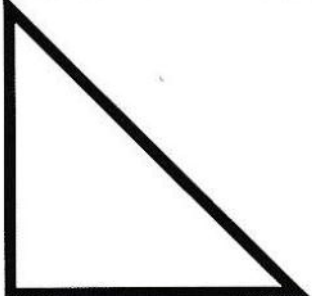

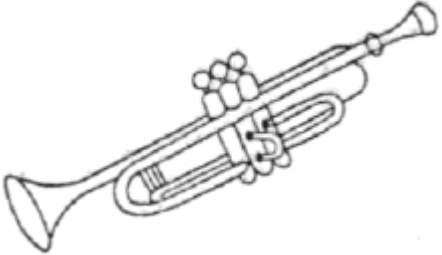

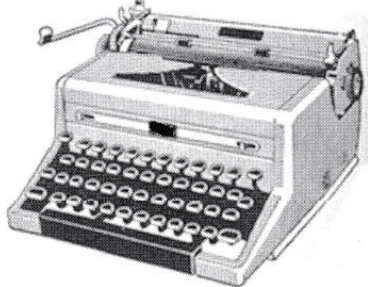
152	Soap Dish		साबुनदानी
153	Socks		जुराबें
154	Sofa		सोफा
155	<p>Spanner (In all States and Union Territories except in the States of Bihar and Jharkhand)</p>		<p>स्पैनर (बिहार एवं झारखण्ड राज्यों को छोड़कर सभी राज्यों और संघ राज्य क्षेत्रों में)</p>
156	Stapler		स्टैपलर





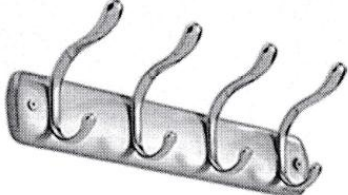
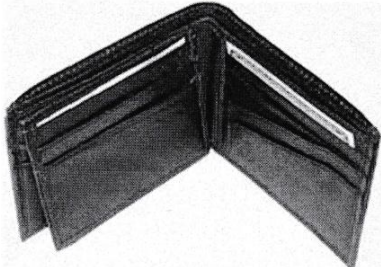
157	Stethoscope		स्टैथोस्कोप
158	Stool		स्टूल
159	Stumps		स्पम्प्स
160	Swing		झूला
161	Switch Board		स्विच बोर्ड



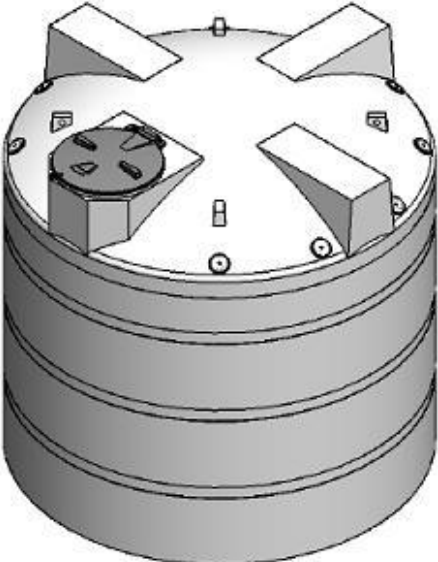

162	Syringe		सिरिन्ज
163	T.V. Remote		टी.वी. रिमोट
164	Table		मेज
165	Tea Filter		चाय छलनी
166	Telephone		टेलीफोन


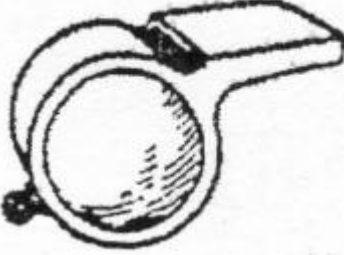
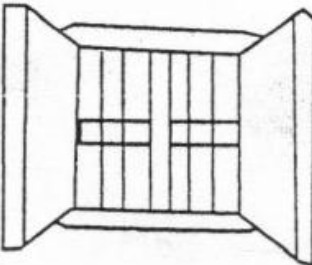

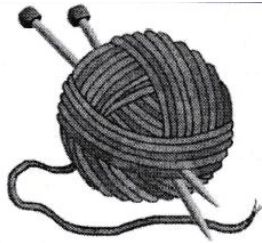
167	Television		टेलीविजन
168	Tennis Racket & Ball		टेनिस बल्ला व गेंद
169	Tent		टैन्ट
170	Throwing a Javelin		भाला फेंक
171	Tiller		टीलर

172	Toffees		टॉफियाँ
173	Tongs <i>(In all States and Union Territories except in the States of Bihar and Jharkhand)</i>		चिमटा <i>(बिहार एवं झारखण्ड राज्यों को छोड़कर सभी राज्यों और संघ राज्य क्षेत्रों में)</i>
174	Tooth Brush		दॉत ब्रुश
175	Tooth Paste		टूथपेस्ट
176	Tractor Chalata Kisan		ट्रैक्टर चलाता किसान
177	Tray		ट्रे

178	Triangle		त्रिभुज
179	Truck		ट्रक
180	Trumpet		तुरही
181	Tube light		ट्यूब लाईट
182	Typewriter		टाईपमशीन

183	Tyres		टायर
184	Vacuum Cleaner		वैक्यूम क्लीनर
185	Violin		वायलिन
186	Walking Stick		छड़ी
187	Wall Hook		दीवार खूंटी
188	Wallet		बटुआ

189	Walnut		अखरोट
190	Water Melon		तरबूज
191	Water Tank		पानी का टैंक
192	Well		कुआँ

193	Wheel Barrow		हाथ रेहडी
194	Whistle		सीटी
195	Window		खिड़की
196	Winnower		सूप
197	Wool and Needle		ऊन व सिलाई